

Opto Coupler • Axial Leaded • Epoxy Molded

ABSOLUTE MAXIMUM RATINGS

LED

- Forward DC Current 100 mA
- Surge Current (tp = 10 μs) 2.5 A
- Reverse Voltage 5 V
- Power Dissipation (25°C) 200 mW

Photodiode

- Reverse Voltage 10,000 V
- Power Dissipation 1.0 W

- Storage Temperature -40°C to +125°C
- Operating Temperature -40°C to +100°C
- Isolation Test Voltage 25 kV (From Pins 1, 2, 3 & 4 to Pins 5 & 6)

ELECTRICAL CHARACTERISTICS

LED

- Forward Voltage (If = 100 mA) 1.5 V
- Reverse Leakage Current 10nA
VR = 5 V

Photodiode

- Forward Voltage (If = 0.6 A) 12.0 V MAX
- Reverse Leakage Current
VR = 10 kV, I_{LED} = 0 mA 250 nA Typical
VR = 10 kV, I_{LED} = 100 mA 100 μA Typical

Coupled

- DC Current Transfer Ratio 0.064% MIN
(I_{LED} = 50 mA, VR = 10 kV)
- t_{ON} (Typical) 2 μs
- t_{OFF} (Typical) 2 μs
(25°C UNLESS OTHERWISE NOTED)

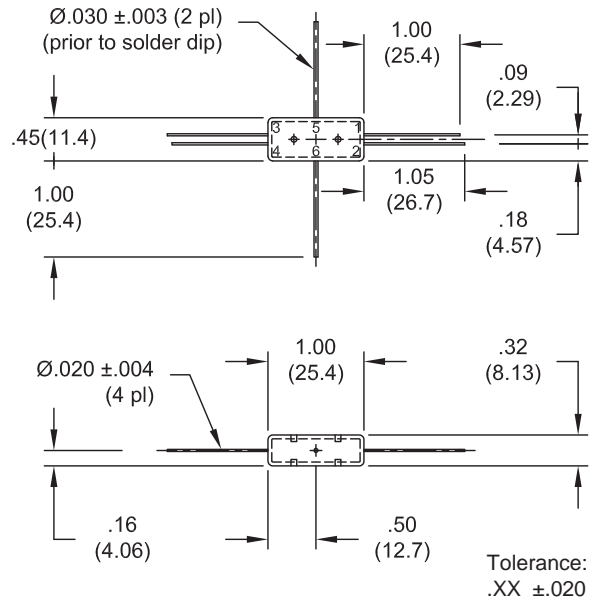

Simplified Circuit Schematic

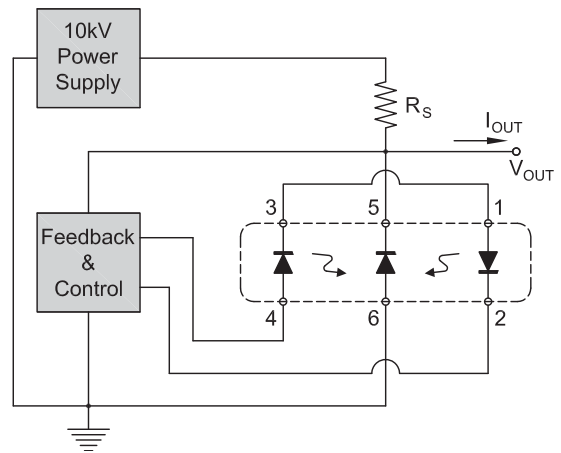
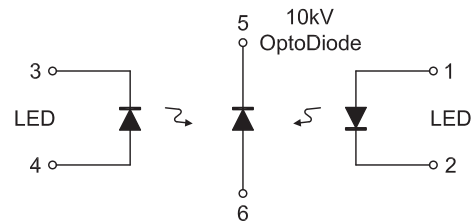

Typical HV Linear Regulator Circuit

- Select resistor value R_S to optimize circuit for V_{OUT} and I_{OUT} range.

Dimensions: In. (mm) • All temperatures are ambient unless otherwise noted. • Data subject to change without notice.



Voltage Multipliers Inc.

8711 W. Roosevelt Ave.
Visalia, CA 93291 USA

Tel: 559.651.1402
Fax: 559.651.0740

www.voltagemultipliers.com
www.highvoltagepowersupplies.com

OC100

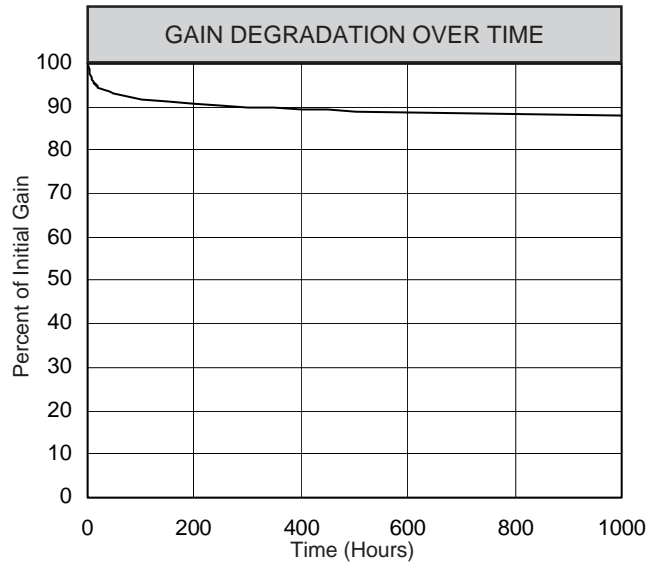
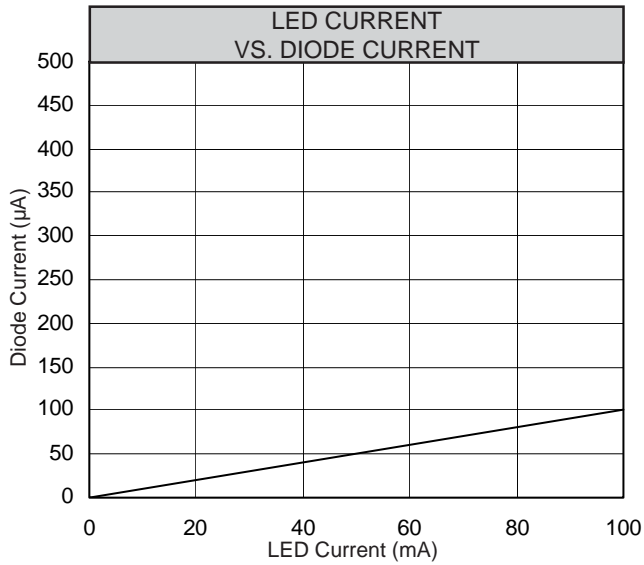
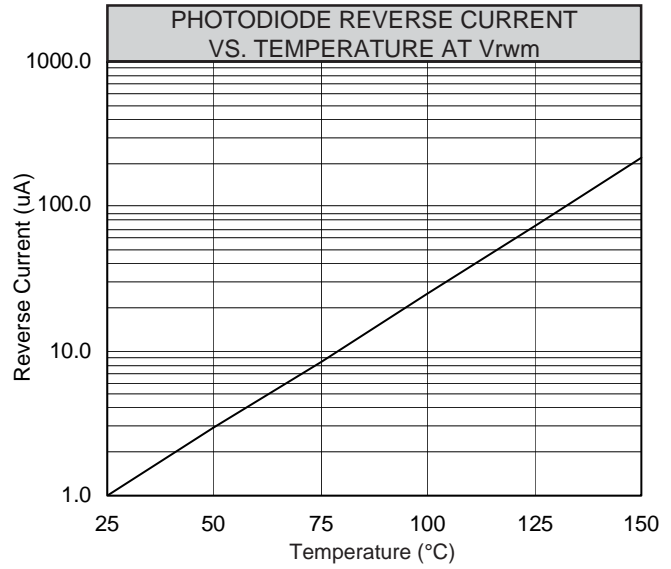
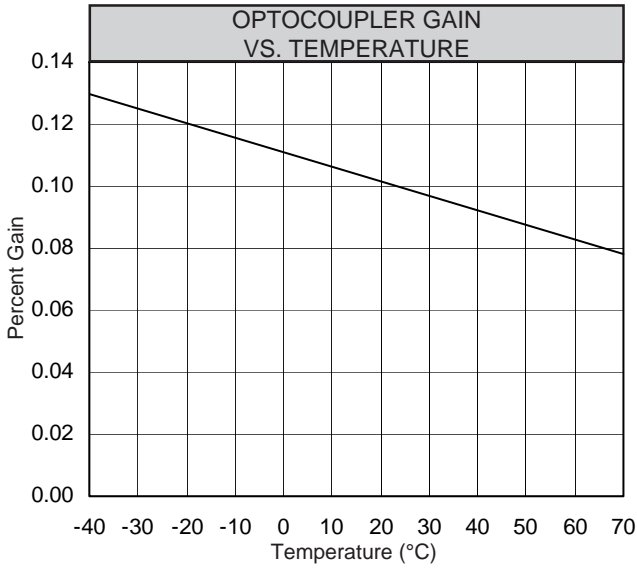

Dimensions: In. (mm) • All temperatures are ambient unless otherwise noted. • Data subject to change without notice.



Voltage Multipliers Inc.

8711 W. Roosevelt Ave.
Visalia, CA 93291 USA

Tel: 559.651.1402
Fax: 559.651.0740

www.voltagemultipliers.com
www.highvoltagepowersupplies.com