

## Opto Coupler • Axial Leaded • Epoxy Molded

### ABSOLUTE MAXIMUM RATINGS

#### LED

- Forward DC Current 100 mA
- Surge Current (tp = 100  $\mu$ s) 1.5 A
- Reverse Voltage 5 V
- Power Dissipation (25°C) 160 mW

#### Photodiode

- Reverse Voltage 10,000 V
- Power Dissipation 1.0 W

- Storage Temperature -40°C to +100°C
- Operating Temperature -40°C to +70°C
- Isolation Test Voltage 25 kV (From Pins 1, 2, 3 & 4 to Pins 5 & 6)

### ELECTRICAL CHARACTERISTICS

#### LED

- Forward Voltage (If = 20 mA) 1.5 V
- Reverse Leakage Current 10  $\mu$ A  
VR = 5 V

#### Photodiode

- Forward Voltage (If = 0.6 A) 12.0 V MAX
- Reverse Leakage Current  
VR = 10 kV, I<sub>LED</sub> = 0 mA 250 nA Typical  
VR = 10 kV, I<sub>LED</sub> = 50 mA 180  $\mu$ A Typical

#### Coupled

- DC Current Transfer Ratio 0.32% MIN  
(I<sub>LED</sub> = 50 mA, VR = 10kV)
- t<sub>ON</sub> (Typical) 2  $\mu$ s
- t<sub>OFF</sub> (Typical) 2  $\mu$ s  
(25°C UNLESS OTHERWISE NOTED)

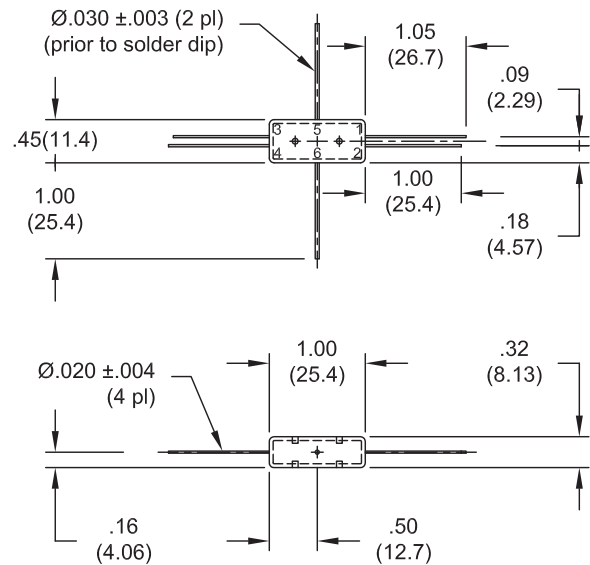

Tolerance:  
.XX ±.020

#### Simplified Circuit Schematic

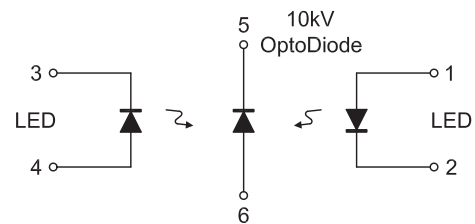

Dimensions: In. (mm) • All temperatures are ambient unless otherwise noted. • Data subject to change without notice.



Voltage Multipliers Inc.

8711 W. Roosevelt Ave.  
Visalia, CA 93291 USA

Tel: 559.651.1402  
Fax: 559.651.0740

www.voltagemultipliers.com  
www.highvoltagepowersupplies.com

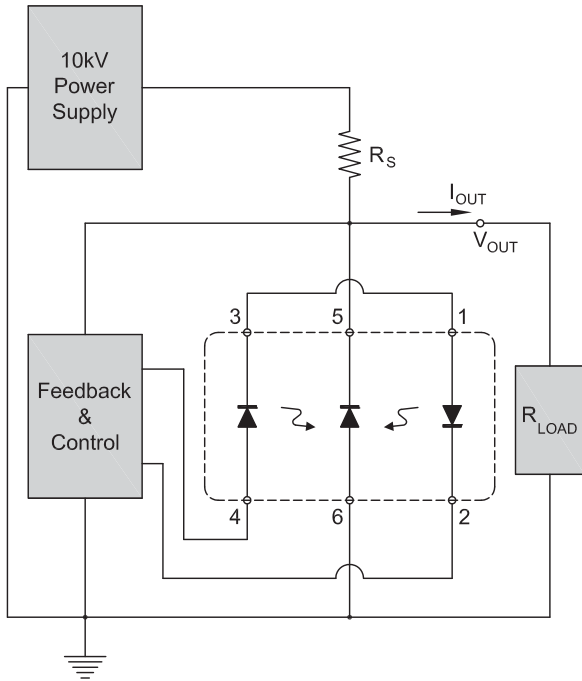

### Typical HV Linear Regulator Circuit

- The two graphs below represent the relationship between output voltage and LED current with different values of  $R_s$ .
- Output voltage is found by the following formula:  

$$V_{OUT} = V_{IN} - \{[I_{OUT} + (I_{LED} * Gain)] * R_s\}$$
- Select resistor value  $R_s$  to optimize circuit for  $V_{OUT}$  and  $I_{OUT}$  range.

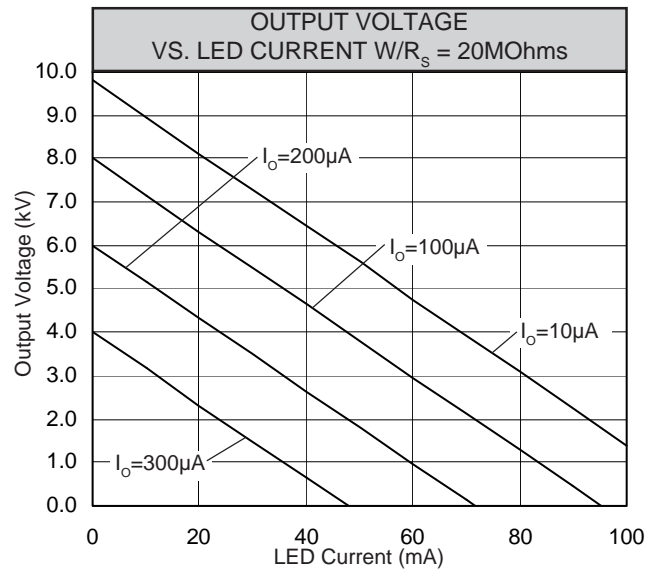
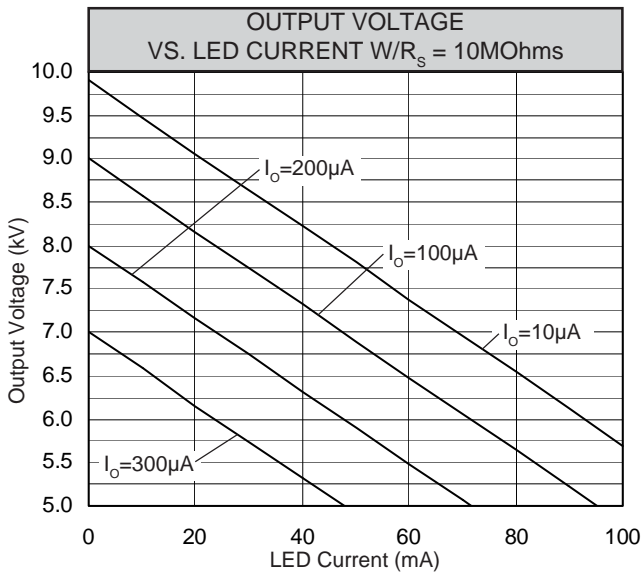

Dimensions: In. (mm) • All temperatures are ambient unless otherwise noted. • Data subject to change without notice.



**Voltage Multipliers Inc.**

8711 W. Roosevelt Ave.  
Visalia, CA 93291 USA

Tel: 559.651.1402  
Fax: 559.651.0740

www.voltagemultipliers.com  
www.highvoltagepowersupplies.com

# OC100G

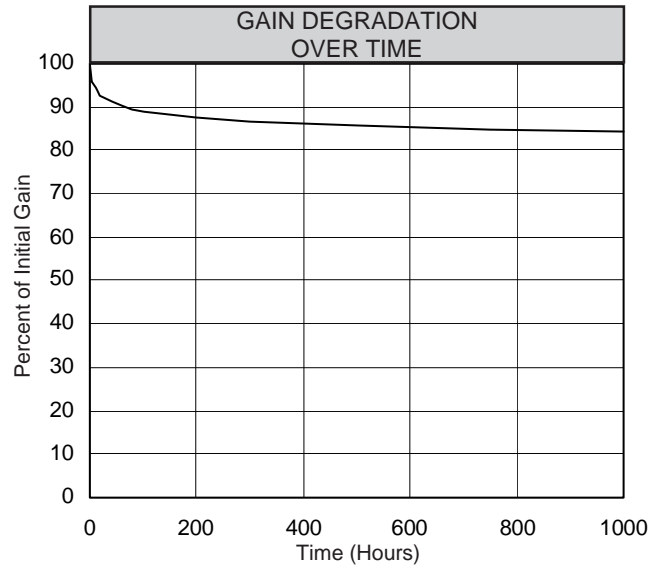
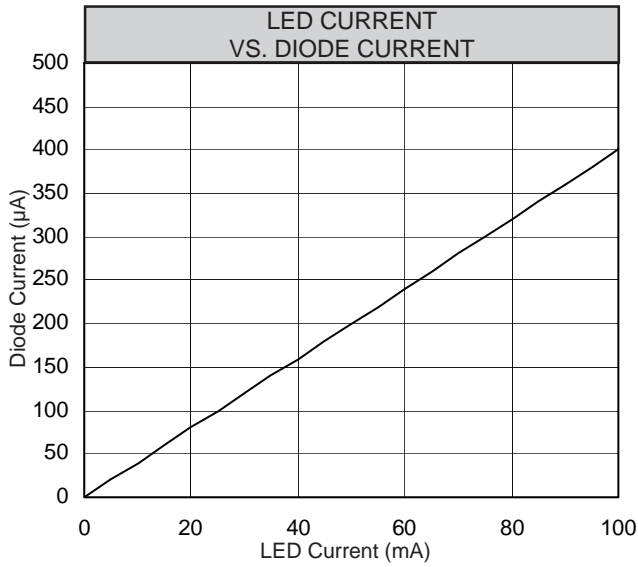
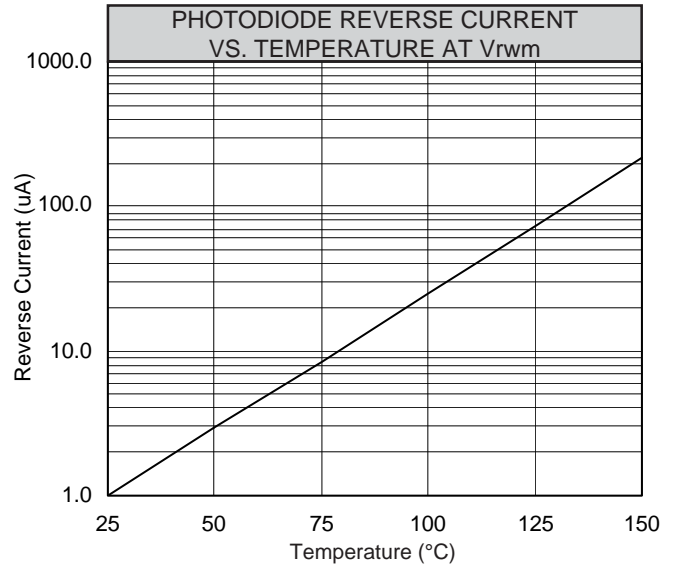
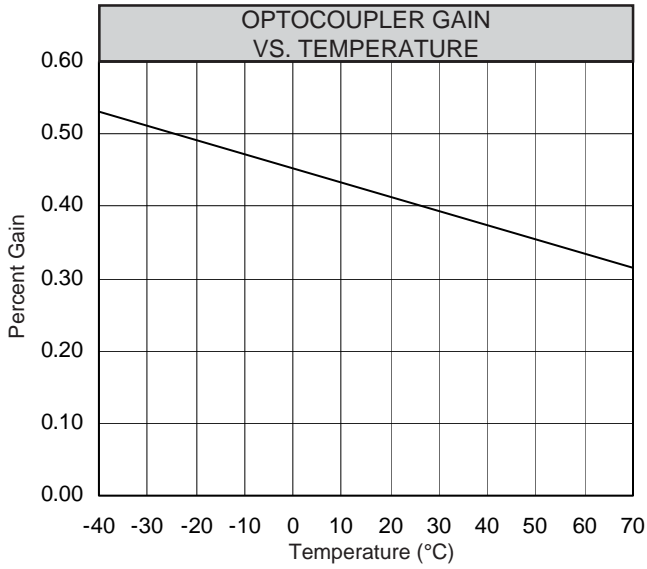

Dimensions: In. (mm) • All temperatures are ambient unless otherwise noted. • Data subject to change without notice.



**Voltage Multipliers Inc.**

8711 W. Roosevelt Ave.  
Visalia, CA 93291 USA

Tel: 559.651.1402  
Fax: 559.651.0740

[www.voltagemultipliers.com](http://www.voltagemultipliers.com)  
[www.highvoltagepowersupplies.com](http://www.highvoltagepowersupplies.com)